



STADLER

L U F T K L I M A



KANTTEILE

VON 0,5 - 4,0mm
STANDARDLÄNGEN 3000/4000mm BZW.
SONDERLÄNGEN BIS 6400mm MÖGLICH

KANTTEILE UND UMFORM-TECHNIK

Wichtige Informationen

Wir sind stets bemüht das beste Ergebnis zu erreichen. Falls Sie spezielle Anforderungen oder außergewöhnliche Materialvorstellungen haben finden wir sicher einen Weg. Sprechen Sie uns gerne an. Telefonisch unter

TEL +49 8265 9694 0

01

RAL-Standardfarbprogramm

Andere RAL-Töne auf Anfrage

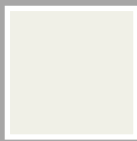

RAL 9010
Reinweiß

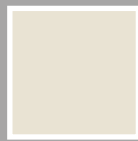

RAL 9001
Cremeweiß



RAL 9002
Grauweiß



RAL 7035
Lichtgrau



RAL 9006
Weißaluminium



RAL 9007
Graualuminium

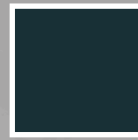

RAL 7016
Anthrazitgrau



RAL 3009
Oxidrot

02

Materialvarianten

Standardmaterialien erhältlich. Andere Materialien auf Anfrage. z.B. Kupfer
RAL = 25 µ polyesterbeschichtetes, verzinktes Stahlblech Materialdicke: 0,75 mm
VZ = Sendzimirverzinktes Blech
VA = Edelstahl 1.4301
ALU = Aluminium

03

Individuelle Abwicklungen

Gerne fertigen wir auch Kantenteile nach Ihren Anforderungen (Zeichnung).
Bleche mit einer Stärke von 0,5 - 4,0mm und einer Länge mit bis zu 6400 mm auf unserer Schwenkbiegemaschine.
3,0 bis 8,0 mm und einer Länge mit bis zu 4000 mm auf unserer Abkantpresse.
Gerne können Sie uns auch Zeichnungen in den CAD-Formaten DXF und DWG zukommen lassen.

04

Lieferung

Auf Wunsch liefern wir Ihnen Ihre Bestellung zu attraktiven Preisen an Ihre Zieladresse.

Alle Angaben vorbehaltlich Satz- & Druckfehler, sowie Änderungen zur Qualitätssteigerung.

Planbare

VERLÄSSLICHKEIT

Die Verarbeitung hochwertiger Materialien mit modernen Fertigungsmaschinen, realisiert durch erfahrene Spezialisten, garantiert höchste Qualität, auf die Sie sich verlassen können!



Ziele erreicht man
am Besten mit zu-
verlässigen Partnern
& wertbeständigen
Komponenten.

Ob Einzelteil oder Serie, zuerst beraten wir Sie ganz individuell, um dann schnell und flexibel Ihren Auftrag zu realisieren. Profitieren Sie von unserer Kompetenz in der Blechverarbeitung seit 1973.

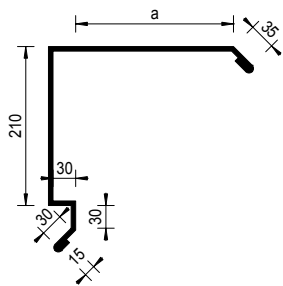

	Maß a	Art.-Nr.
ES01 Ortgang RAL	a = 150	ES01-RAL-0150
	a = 200	ES01-RAL-0200
	a = 250	ES01-RAL-0250
	a = 300	ES01-RAL-0300
	a = 380	ES01-RAL-0380
ES01 Ortgang VZ	a = 150	ES01-VZ-0150
	a = 200	ES01-VZ-0200
	a = 250	ES01-VZ-0250
	a = 300	ES01-VZ-0300
	a = 380	ES01-VZ-0380
ES01 Ortgang VA	a = 150	ES01-VA-0150
	a = 200	ES01-VA-0200
	a = 250	ES01-VA-0250
	a = 300	ES01-VA-0300
	a = 380	ES01-VA-0380
ES01 Ortgang ALU	a = 150	ES01-ALU-0150
	a = 200	ES01-ALU-0200
	a = 250	ES01-ALU-0250
	a = 300	ES01-ALU-0300
	a = 380	ES01-ALU-0380

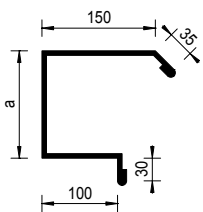

ES02 Ortgang RAL	a = 72	ES02-RAL-0072	
	a = 82	ES02-RAL-0082	
	a = 92	ES02-RAL-0092	
	a = 102	ES02-RAL-0102	
	a = 122	ES02-RAL-0122	
	a = 142	ES02-RAL-0142	
	a = 162	ES02-RAL-0162	
	a = 182	ES02-RAL-0182	
	a = 192	ES02-RAL-0192	
	a = 202	ES02-RAL-0202	
	a = 242	ES02-RAL-0242	
	ES02 Ortgang VZ	a = 72	ES02-VZ-0072
		a = 82	ES02-VZ-0082
a = 92		ES02-VZ-0092	
a = 102		ES02-VZ-0102	
a = 122		ES02-VZ-0122	
a = 142		ES02-VZ-0142	
a = 162		ES02-VZ-0162	
a = 182		ES02-VZ-0182	
a = 192		ES02-VZ-0192	
a = 202		ES02-VZ-0202	
a = 242	ES02-VZ-0242		

HINWEIS

Alle Kantenteile sind in 4 Standardmaterialvarianten in 3.000 / 4.000 mm erhältlich.
 RAL = 25 µ polyesterbeschichtetes, verzinktes Stahlblech Materialdicke: 0,75 mm
 VZ = Sendzimirverzinktes Blech / VA = Edelstahl 1.4301 / ALU = Aluminium

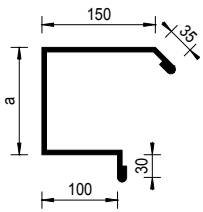

ES02 Ortgang

VA

Maß a

Art.-Nr.

a = 72	ES02-VA-0072
a = 82	ES02-VA-0082
a = 92	ES02-VA-0092
a = 102	ES02-VA-0102
a = 122	ES02-VA-0122
a = 142	ES02-VA-0142
a = 162	ES02-VA-0162
a = 182	ES02-VA-0182
a = 192	ES02-VA-0192
a = 202	ES02-VA-0202
a = 242	ES02-VA-0242

ES02 Ortgang

ALU

a = 72	ES02-ALU-0072
a = 82	ES02-ALU-0082
a = 92	ES02-ALU-0092
a = 102	ES02-ALU-0102
a = 122	ES02-ALU-0122
a = 142	ES02-ALU-0142
a = 162	ES02-ALU-0162
a = 182	ES02-ALU-0182
a = 192	ES02-ALU-0192
a = 202	ES02-ALU-0202
a = 242	ES02-ALU-0242

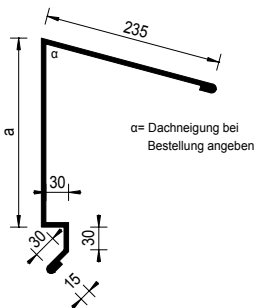

ES03 Pultdach

RAL

a = 210	ES03-RAL-0210
a = 230	ES03-RAL-0230
a = 250	ES03-RAL-0250
a = 300	ES03-RAL-0300

ES03 Pultdach

VZ

a = 210	ES03-VZ-0210
a = 230	ES03-VZ-0230
a = 250	ES03-VZ-0250
a = 300	ES03-VZ-0300

ES03 Pultdach

VA

a = 210	ES03-VA-0210
a = 230	ES03-VA-0230
a = 250	ES03-VA-0250
a = 300	ES03-VA-0300

ES03 Pultdach

ALU

a = 210	ES03-ALU-0210
a = 230	ES03-ALU-0230
a = 250	ES03-ALU-0250
a = 300	ES03-ALU-0300

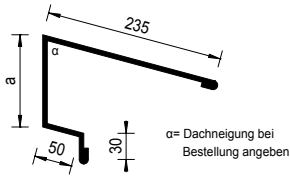





	Maß a	Art.-Nr.
ES04 Pultdach RAL	a = 72	ES04-RAL-0072
	a = 82	ES04-RAL-0082
	a = 92	ES04-RAL-0092
	a = 102	ES04-RAL-0102
	a = 122	ES04-RAL-0122
	a = 142	ES04-RAL-0142
	a = 162	ES04-RAL-0162
	a = 182	ES04-RAL-0182
	a = 192	ES04-RAL-0192
	a = 202	ES04-RAL-0202
	a = 242	ES04-RAL-0242
	ES04 Pultdach VZ	a = 72
a = 82		ES04-VZ-0082
a = 92		ES04-VZ-0092
a = 102		ES04-VZ-0102
a = 122		ES04-VZ-0122
a = 142		ES04-VZ-0142
a = 162		ES04-VZ-0162
a = 182		ES04-VZ-0182
a = 192		ES04-VZ-0192
a = 202		ES04-VZ-0202
a = 242		ES04-VZ-0242
ES04 Pultdach VA		a = 72
	a = 82	ES04-VA-0082
	a = 92	ES04-VA-0092
	a = 102	ES04-VA-0102
	a = 122	ES04-VA-0122
	a = 142	ES04-VA-0142
	a = 162	ES04-VA-0162
	a = 182	ES04-VA-0182
	a = 192	ES04-VA-0192
	a = 202	ES04-VA-0202
	a = 242	ES04-VA-0242
	ES04 Pultdach ALU	a = 72
a = 82		ES04-ALU-0082
a = 92		ES04-ALU-0092
a = 102		ES04-ALU-0102
a = 122		ES04-ALU-0122
a = 142		ES04-ALU-0142
a = 162		ES04-ALU-0162
a = 182		ES04-ALU-0182
a = 192		ES04-ALU-0192
a = 202		ES04-ALU-0202
a = 242		ES04-ALU-0242

HINWEIS

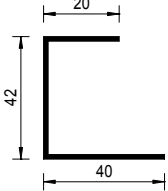
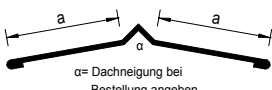
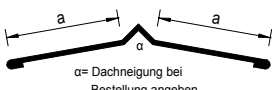
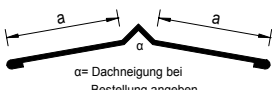
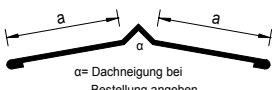
Alle Kantteile sind in 4 Standardmaterialvarianten in 3.000 / 4.000 mm erhältlich.
 RAL = 25 µ polyesterbeschichtetes, verzinktes Stahlblech Materialdicke: 0,75 mm
 VZ = Sendzimirverzinktes Blech / VA = Edelstahl 1.4301 / ALU = Aluminium

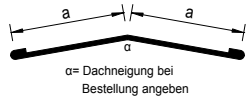

	Maß a	Art.-Nr.	
		ES05 Ausgleichsprofil für ES01-ES02 RAL	ES05-RAL-0042
		ES05 Ausgleichsprofil für ES01-ES02 VZ	ES05-VZ-0042
		ES05 Ausgleichsprofil für ES01-ES02 VA	ES05-VA-0042
		ES05 Ausgleichsprofil für ES01-ES02 ALU	ES05-ALU-0042
	a = 200	ES06 Firstprofil außen RAL	ES06-RAL-0200
	a = 250		ES06-RAL-0250
	a = 300		ES06-RAL-0300
	a = 350		ES06-RAL-0350
	a = 200	ES06 Firstprofil außen VZ	ES06-VZ-0200
	a = 250		ES06-VZ-0250
	a = 300		ES06-VZ-0300
	a = 350		ES06-VZ-0350
	a = 200	ES06 Firstprofil außen VA	ES06-VA-0200
	a = 250		ES06-VA-0250
	a = 300		ES06-VA-0300
	a = 350		ES06-VA-0350
	a = 200	ES06 Firstprofil außen ALU	ES06-ALU-0200
	a = 250		ES06-ALU-0250
	a = 300		ES06-ALU-0300
	a = 350		ES06-ALU-0350
	a = 200	ES07 Firstprofil außen RAL	ES07-RAL-0200
	a = 250		ES07-RAL-0250
	a = 300		ES07-RAL-0300
	a = 350		ES07-RAL-0350
	a = 200	ES07 Firstprofil außen VZ	ES07-VZ-0200
	a = 250		ES07-VZ-0250
	a = 300		ES07-VZ-0300
	a = 350		ES07-VZ-0350
	a = 200	ES07 Firstprofil außen VA	ES07-VA-0200
	a = 250		ES07-VA-0250
	a = 300		ES07-VA-0300
	a = 350		ES07-VA-0350
	a = 200	ES07 Firstprofil außen ALU	ES07-ALU-0200
	a = 250		ES07-ALU-0250
	a = 300		ES07-ALU-0300
	a = 350		ES07-ALU-0350

ES08 Firstprofil innen

RAL

Maß a
Art.-Nr.

a = 150

ES08-RAL-0150

a = 200

ES08-RAL-0200

a = 250

ES08-RAL-0250

ES08 Firstprofil innen

VZ

a = 150

ES08-VZ-0150

a = 200

ES08-VZ-0200

a = 250

ES08-VZ-0250

ES08 Firstprofil innen

VA

a = 150

ES08-VA-0150

a = 200

ES08-VA-0200

a = 250

ES08-VA-0250

ES08 Firstprofil innen

ALU

a = 150

ES08-ALU-0150

a = 200

ES08-ALU-0200

a = 250

ES08-ALU-0250

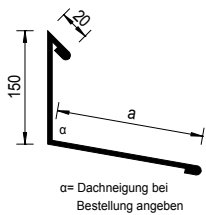
ES09 Wandanschluss

RAL

a = 200

ES09-RAL-0200

a = 250

ES09-RAL-0250

a = 300

ES09-RAL-0300

ES09 Wandanschluss

VZ

a = 200

ES09-VZ-0200

a = 250

ES09-VZ-0250

a = 300

ES09-VZ-0300

ES09 Wandanschluss

VA

a = 200

ES09-VA-0200

a = 250

ES09-VA-0250

a = 300

ES09-VA-0300

ES09 Wandanschluss

ALU

a = 200

ES09-ALU-0200

a = 250

ES09-ALU-0250

a = 300

ES09-ALU-0300

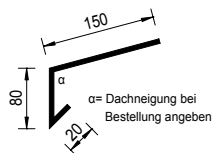
ES10 Rinnen Einlaufblech

RAL

ES10-RAL-0150

ES10 Rinnen Einlaufblech

VZ

ES10-VZ-0150

ES10 Rinnen Einlaufblech

VA

ES10-VA-0150

ES10 Rinnen Einlaufblech

ALU

ES10-ALU-0150

HINWEIS

Alle Kantteile sind in 4 Standardmaterialvarianten in 3.000 / 4.000 mm erhältlich.

RAL = 25 µ polyesterbeschichtetes, verzinktes Stahlblech Materialdicke: 0,75 mm

VZ = Sendzimirverzinktes Blech / VA = Edelstahl 1.4301 / ALU = Aluminium

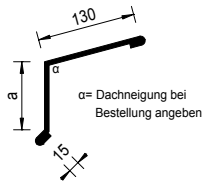

	Maß a	Art.-Nr.
ES11 Wasser Abweisblech RAL	a = 90	ES11-RAL-0090
	a = 100	ES11-RAL-0100
	a = 110	ES11-RAL-0110
	a = 120	ES11-RAL-0120
	a = 140	ES11-RAL-0140
	a = 160	ES11-RAL-0160
	a = 180	ES11-RAL-0180
	a = 200	ES11-RAL-0200
	a = 220	ES11-RAL-0220
	a = 260	ES11-RAL-0260
ES11 Wasser Abweisblech VZ	a = 90	ES11-VZ-0090
	a = 100	ES11-VZ-0100
	a = 110	ES11-VZ-0110
	a = 120	ES11-VZ-0120
	a = 140	ES11-VZ-0140
	a = 160	ES11-VZ-0160
	a = 180	ES11-VZ-0180
	a = 200	ES11-VZ-0200
	a = 220	ES11-VZ-0220
	a = 260	ES11-VZ-0260
ES11 Wasser Abweisblech VA	a = 90	ES11-VA-0090
	a = 100	ES11-VA-0100
	a = 110	ES11-VA-0110
	a = 120	ES11-VA-0120
	a = 140	ES11-VA-0140
	a = 160	ES11-VA-0160
	a = 180	ES11-VA-0180
	a = 200	ES11-VA-0200
	a = 220	ES11-VA-0220
	a = 260	ES11-VA-0260
ES11 Wasser Abweisblech ALU	a = 90	ES11-ALU-0090
	a = 100	ES11-ALU-0100
	a = 110	ES11-ALU-0110
	a = 120	ES11-ALU-0120
	a = 140	ES11-ALU-0140
	a = 160	ES11-ALU-0160
	a = 180	ES11-ALU-0180
	a = 200	ES11-ALU-0200
	a = 220	ES11-ALU-0220
	a = 260	ES11-ALU-0260

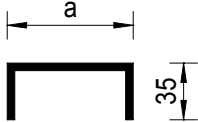
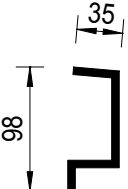
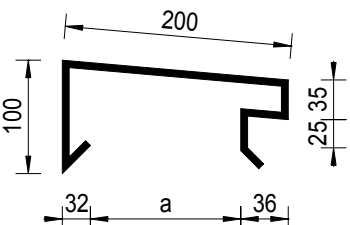
	Maß a	Art.-Nr.		
	ES12 U-Profil für Attika-			
	befestigung, t = 1,5 mm			
	VZ			
	a = 40	ES12-VZ-0040		
	a = 50	ES12-VZ-0050		
	a = 60	ES12-VZ-0060		
	a = 80	ES12-VZ-0080		
	a = 100	ES12-VZ-0100		
	a = 120	ES12-VZ-0120		
	a = 140	ES12-VZ-0140		
	a = 150	ES12-VZ-0150		
	a = 160	ES12-VZ-0160		
	a = 170	ES12-VZ-0170		
	a = 180	ES12-VZ-0180		
a = 200	ES12-VZ-0200			
a = 220	ES12-VZ-0220			
a = 240	ES12-VZ-0240			
	ES13 Attika Unter-			
	konstruktion, t = 1,5 mm			
VZ		ES13-VZ-0098		
	ES14 Attika Aufsatz			
	RAL		a = 40	ES14-RAL-0040
			a = 50	ES14-RAL-0050
			a = 60	ES14-RAL-0060
			a = 80	ES14-RAL-0080
			a = 100	ES14-RAL-0100
			a = 120	ES14-RAL-0120
			a = 140	ES14-RAL-0140
			a = 150	ES14-RAL-0150
			a = 160	ES14-RAL-0160
			a = 170	ES14-RAL-0170
			a = 180	ES14-RAL-0180
			a = 200	ES14-RAL-0200
			a = 220	ES14-RAL-0220
		a = 240	ES14-RAL-0240	
	ES14 Attika Aufsatz			
	VZ		a = 40	ES14-VZ-0040
			a = 50	ES14-VZ-0050
			a = 60	ES14-VZ-0060
			a = 80	ES14-VZ-0080
			a = 100	ES14-VZ-0100
			a = 120	ES14-VZ-0120
			a = 140	ES14-VZ-0140
			a = 150	ES14-VZ-0150
			a = 160	ES14-VZ-0160
			a = 170	ES14-VZ-0170
			a = 180	ES14-VZ-0180
			a = 200	ES14-VZ-0200
			a = 220	ES14-VZ-0220
		a = 240	ES14-VZ-0240	

HINWEIS

Alle Kantenteile sind in 4 Standardmaterialvarianten in 3.000 / 4.000 mm erhältlich.
RAL = 25 µ polyesterbeschichtetes, verzinktes Stahlblech Materialdicke: 0,75 mm
VZ = Sendzimirverzinktes Blech / VA = Edelstahl 1.4301 / ALU = Aluminium

Maß a

Art.-Nr.

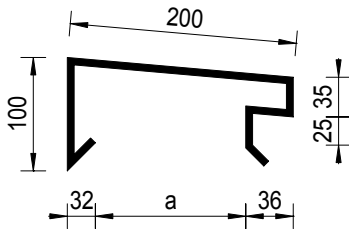

ES14 Attika Aufsatz

VA

a = 40	ES14-VA-0040
a = 50	ES14-VA-0050
a = 60	ES14-VA-0060
a = 80	ES14-VA-0080
a = 100	ES14-VA-0100
a = 120	ES14-VA-0120
a = 140	ES14-VA-0140
a = 150	ES14-VA-0150
a = 160	ES14-VA-0160
a = 170	ES14-VA-0170
a = 180	ES14-VA-0180
a = 200	ES14-VA-0200
a = 220	ES14-VA-0220
a = 240	ES14-VA-0240

ES14 Attika Aufsatz

ALU

a = 40	ES14-ALU-0040
a = 50	ES14-ALU-0050
a = 60	ES14-ALU-0060
a = 80	ES14-ALU-0080
a = 100	ES14-ALU-0100
a = 120	ES14-ALU-0120
a = 140	ES14-ALU-0140
a = 150	ES14-ALU-0150
a = 160	ES14-ALU-0160
a = 170	ES14-ALU-0170
a = 180	ES14-ALU-0180
a = 200	ES14-ALU-0200
a = 220	ES14-ALU-0220
a = 240	ES14-ALU-0240

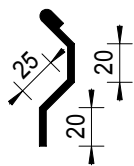

ES15 Tropfprofil

RAL

ES15-RAL-0020

ES15 Tropfprofil

VZ

ES15-VZ-0020

ES15 Tropfprofil

VA

ES15-VA-0020

ES15 Tropfprofil

ALU

ES15-ALU-0020

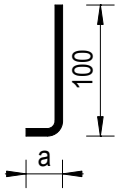
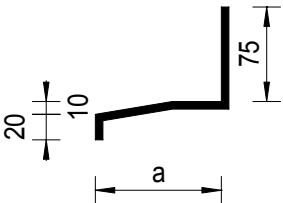
	Maß a	Art.-Nr.
 <p>ES16 Halteprofil vertikal, t = 2,5 mm VZ</p>	a = 30	ES16-VZ-0030
	a = 40	ES16-VZ-0040
	a = 50	ES16-VZ-0050
	a = 60	ES16-VZ-0060
	a = 70	ES16-VZ-0070
	a = 75	ES16-VZ-0075
	a = 80	ES16-VZ-0080
	a = 85	ES16-VZ-0085
	a = 90	ES16-VZ-0090
	a = 100	ES16-VZ-0100
	a = 110	ES16-VZ-0110
	a = 120	ES16-VZ-0120
	 <p>ES17 Sockelprofil RAL</p>	a = 40
a = 50		ES17-RAL-0050
a = 60		ES17-RAL-0060
a = 80		ES17-RAL-0080
a = 100		ES17-RAL-0100
a = 120		ES17-RAL-0120
a = 140		ES17-RAL-0140
a = 150		ES17-RAL-0150
a = 160		ES17-RAL-0160
a = 170		ES17-RAL-0170
a = 180		ES17-RAL-0180
a = 200		ES17-RAL-0200
a = 220		ES17-RAL-0220
a = 240	ES17-RAL-0240	
<p>ES17 Sockelprofil VZ</p>	a = 40	ES17-VZ-0040
	a = 50	ES17-VZ-0050
	a = 60	ES17-VZ-0060
	a = 80	ES17-VZ-0080
	a = 100	ES17-VZ-0100
	a = 120	ES17-VZ-0120
	a = 140	ES17-VZ-0140
	a = 150	ES17-VZ-0150
	a = 160	ES17-VZ-0160
	a = 170	ES17-VZ-0170
	a = 180	ES17-VZ-0180
	a = 200	ES17-VZ-0200
	a = 220	ES17-VZ-0220
a = 240	ES17-VZ-0240	

HINWEIS

Alle Kantenteile sind in 4 Standardmaterialvarianten in 3.000 / 4.000 mm erhältlich.

RAL = 25 µ polyesterbeschichtetes, verzinktes Stahlblech Materialdicke: 0,75 mm

VZ = Sendzimirverzinktes Blech / VA = Edelstahl 1.4301 / ALU = Aluminium

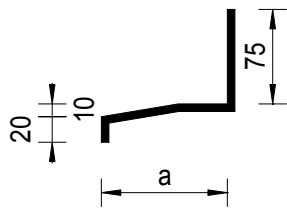

ES17 Sockelprofil

VA

Maß a

Art.-Nr.

a = 40	ES17-VA-0040
a = 50	ES17-VA-0050
a = 60	ES17-VA-0060
a = 80	ES17-VA-0080
a = 100	ES17-VA-0100
a = 120	ES17-VA-0120
a = 140	ES17-VA-0140
a = 150	ES17-VA-0150
a = 160	ES17-VA-0160
a = 170	ES17-VA-0170
a = 180	ES17-VA-0180
a = 200	ES17-VA-0200
a = 220	ES17-VA-0220
a = 240	ES17-VA-0240

ES17 Sockelprofil

ALU

a = 40	ES17-ALU-0040
a = 50	ES17-ALU-0050
a = 60	ES17-ALU-0060
a = 80	ES17-ALU-0080
a = 100	ES17-ALU-0100
a = 120	ES17-ALU-0120
a = 140	ES17-ALU-0140
a = 150	ES17-ALU-0150
a = 160	ES17-ALU-0160
a = 170	ES17-ALU-0170
a = 180	ES17-ALU-0180
a = 200	ES17-ALU-0200
a = 220	ES17-ALU-0220
a = 240	ES17-ALU-0240

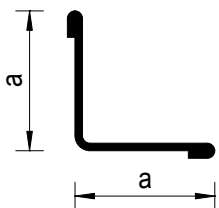

ES18 Innen-Anschluss- winkel

RAL

a = 50	ES18-RAL-0050
a = 80	ES18-RAL-0080
a = 100	ES18-RAL-0100

ES18 Innen-Anschluss- winkel

VZ

a = 50	ES18-VZ-0050
a = 80	ES18-VZ-0080
a = 100	ES18-VZ-0100

ES18 Innen-Anschluss- winkel

VA

a = 50	ES18-VA-0050
a = 80	ES18-VA-0080
a = 100	ES18-VA-0100

ES18 Innen-Anschluss- winkel

ALU

a = 50	ES18-ALU-0050
a = 80	ES18-ALU-0080
a = 100	ES18-ALU-0100

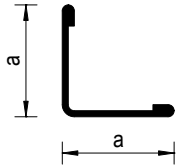

	Maß a	Art.-Nr.
ES19 Aussenwinkel gleichschenkelig RAL	a = 60	ES19-RAL-0060
	a = 80	ES19-RAL-0080
	a = 100	ES19-RAL-0100
	a = 120	ES19-RAL-0120
	a = 140	ES19-RAL-0140
	a = 160	ES19-RAL-0160
	a = 180	ES19-RAL-0180
	a = 200	ES19-RAL-0200
	a = 220	ES19-RAL-0220
	a = 240	ES19-RAL-0240
	a = 260	ES19-RAL-0260
	a = 280	ES19-RAL-0280
	a = 300	ES19-RAL-0300
ES19 Aussenwinkel gleichschenkelig VZ	a = 60	ES19-VZ-0060
	a = 80	ES19-VZ-0080
	a = 100	ES19-VZ-0100
	a = 120	ES19-VZ-0120
	a = 140	ES19-VZ-0140
	a = 160	ES19-VZ-0160
	a = 180	ES19-VZ-0180
	a = 200	ES19-VZ-0200
	a = 220	ES19-VZ-0220
	a = 240	ES19-VZ-0240
	a = 260	ES19-VZ-0260
	a = 280	ES19-VZ-0280
	a = 300	ES19-VZ-0300
ES19 Aussenwinkel gleichschenkelig VA	a = 60	ES19-VA-0060
	a = 80	ES19-VA-0080
	a = 100	ES19-VA-0100
	a = 120	ES19-VA-0120
	a = 140	ES19-VA-0140
	a = 160	ES19-VA-0160
	a = 180	ES19-VA-0180
	a = 200	ES19-VA-0200
	a = 220	ES19-VA-0220
	a = 240	ES19-VA-0240
	a = 260	ES19-VA-0260
	a = 280	ES19-VA-0280
	a = 300	ES19-VA-0300
ES19 Aussenwinkel gleichschenkelig ALU	a = 60	ES19-ALU-0060
	a = 80	ES19-ALU-0080
	a = 100	ES19-ALU-0100
	a = 120	ES19-ALU-0120
	a = 140	ES19-ALU-0140
	a = 160	ES19-ALU-0160
	a = 180	ES19-ALU-0180
	a = 200	ES19-ALU-0200
	a = 220	ES19-ALU-0220
	a = 240	ES19-ALU-0240
	a = 260	ES19-ALU-0260
	a = 280	ES19-ALU-0280
	a = 300	ES19-ALU-0300

HINWEIS

Alle Kantenteile sind in 4 Standardmaterialvarianten in 3.000 / 4.000 mm erhältlich.

RAL = 25 µ polyesterbeschichtetes, verzinktes Stahlblech Materialdicke: 0,75 mm

VZ = Sendzimirverzinktes Blech / VA = Edelstahl 1.4301 / ALU = Aluminium

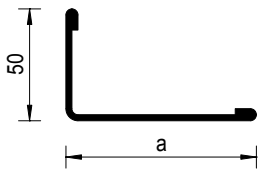

	Maß a	Art.-Nr.
ES20 Aussenwinkel ungleichschenkelig RAL	a = 60	ES20-RAL-0060
	a = 80	ES20-RAL-0080
	a = 100	ES20-RAL-0100
	a = 120	ES20-RAL-0120
	a = 140	ES20-RAL-0140
	a = 160	ES20-RAL-0160
	a = 180	ES20-RAL-0180
	a = 200	ES20-RAL-0200
	a = 220	ES20-RAL-0220
	a = 240	ES20-RAL-0240
	a = 260	ES20-RAL-0260
	a = 280	ES20-RAL-0280
	a = 300	ES20-RAL-0300
ES20 Aussenwinkel ungleichschenkelig VZ	a = 60	ES20-VZ-0060
	a = 80	ES20-VZ-0080
	a = 100	ES20-VZ-0100
	a = 120	ES20-VZ-0120
	a = 140	ES20-VZ-0140
	a = 160	ES20-VZ-0160
	a = 180	ES20-VZ-0180
	a = 200	ES20-VZ-0200
	a = 220	ES20-VZ-0220
	a = 240	ES20-VZ-0240
	a = 260	ES20-VZ-0260
	a = 280	ES20-VZ-0280
	a = 300	ES20-VZ-0300
ES20 Aussenwinkel ungleichschenkelig VA	a = 60	ES20-VA-0060
	a = 80	ES20-VA-0080
	a = 100	ES20-VA-0100
	a = 120	ES20-VA-0120
	a = 140	ES20-VA-0140
	a = 160	ES20-VA-0160
	a = 180	ES20-VA-0180
	a = 200	ES20-VA-0200
	a = 220	ES20-VA-0220
	a = 240	ES20-VA-0240
	a = 260	ES20-VA-0260
	a = 280	ES20-VA-0280
	a = 300	ES20-VA-0300
ES20 Aussenwinkel ungleichschenkelig ALU	a = 60	ES20-ALU-0060
	a = 80	ES20-ALU-0080
	a = 100	ES20-ALU-0100
	a = 120	ES20-ALU-0120
	a = 140	ES20-ALU-0140
	a = 160	ES20-ALU-0160
	a = 180	ES20-ALU-0180
	a = 200	ES20-ALU-0200
	a = 220	ES20-ALU-0220
	a = 240	ES20-ALU-0240
	a = 260	ES20-ALU-0260
	a = 280	ES20-ALU-0280
	a = 300	ES20-ALU-0300

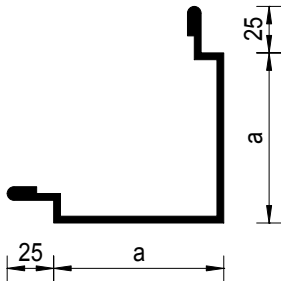

	Maß a	Art.-Nr.
ES21 Außeneckprofil RAL	a = 80	ES21-RAL-0080
	a = 100	ES21-RAL-0100
	a = 120	ES21-RAL-0120
	a = 140	ES21-RAL-0140
	a = 160	ES21-RAL-0160
	a = 180	ES21-RAL-0180
	a = 200	ES21-RAL-0200
	a = 220	ES21-RAL-0220
	a = 240	ES21-RAL-0240
	a = 260	ES21-RAL-0260
ES21 Außeneckprofil VZ	a = 80	ES21-VZ-0080
	a = 100	ES21-VZ-0100
	a = 120	ES21-VZ-0120
	a = 140	ES21-VZ-0140
	a = 160	ES21-VZ-0160
	a = 180	ES21-VZ-0180
	a = 200	ES21-VZ-0200
	a = 220	ES21-VZ-0220
	a = 240	ES21-VZ-0240
	a = 260	ES21-VZ-0260
ES21 Außeneckprofil VA	a = 80	ES21-VA-0080
	a = 100	ES21-VA-0100
	a = 120	ES21-VA-0120
	a = 140	ES21-VA-0140
	a = 160	ES21-VA-0160
	a = 180	ES21-VA-0180
	a = 200	ES21-VA-0200
	a = 220	ES21-VA-0220
	a = 240	ES21-VA-0240
	a = 260	ES21-VA-0260
ES21 Außeneckprofil ALU	a = 80	ES21-ALU-0080
	a = 100	ES21-ALU-0100
	a = 120	ES21-ALU-0120
	a = 140	ES21-ALU-0140
	a = 160	ES21-ALU-0160
	a = 180	ES21-ALU-0180
	a = 200	ES21-ALU-0200
	a = 220	ES21-ALU-0220
	a = 240	ES21-ALU-0240
	a = 260	ES21-ALU-0260

HINWEIS

Alle Kantenteile sind in 4 Standardmaterialvarianten in 3.000 / 4.000 mm erhältlich.

RAL = 25 µ polyesterbeschichtetes, verzinktes Stahlblech Materialdicke: 0,75 mm

VZ = Sendzimirverzinktes Blech / VA = Edelstahl 1.4301 / ALU = Aluminium

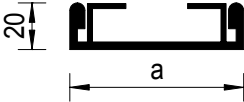
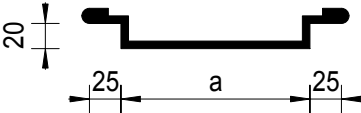
	Maß a	Art.-Nr.
	ES22 Stoßabdeckung inkl. 2 Winkel RAL	a = 150 ES22-RAL-0150 a = 200 ES22-RAL-0200 a = 250 ES22-RAL-0250 a = 300 ES22-RAL-0300
	ES22 Stoßabdeckung inkl. 2 Winkel VZ	a = 150 ES22-VZ-0150 a = 200 ES22-VZ-0200 a = 250 ES22-VZ-0250 a = 300 ES22-VZ-0300
	ES22 Stoßabdeckung inkl. 2 Winkel VA	a = 150 ES22-VA-0150 a = 200 ES22-VA-0200 a = 250 ES22-VA-0250 a = 300 ES22-VA-0300
	ES22 Stoßabdeckung inkl. 2 Winkel ALU	a = 150 ES22-ALU-0150 a = 200 ES22-ALU-0200 a = 250 ES22-ALU-0250 a = 300 ES22-ALU-0300
	ES23 Stoßabdeckung horizontal RAL	a = 50 ES23-RAL-0050 a = 100 ES23-RAL-0100 a = 150 ES23-RAL-0150 a = 200 ES23-RAL-0200
	ES23 Stoßabdeckung horizontal VZ	a = 50 ES23-VZ-0050 a = 100 ES23-VZ-0100 a = 150 ES23-VZ-0150 a = 200 ES23-VZ-0200
	ES23 Stoßabdeckung horizontal VA	a = 50 ES23-VA-0050 a = 100 ES23-VA-0100 a = 150 ES23-VA-0150 a = 200 ES23-VA-0200
	ES23 Stoßabdeckung horizontal ALU	a = 50 ES23-ALU-0050 a = 100 ES23-ALU-0100 a = 150 ES23-ALU-0150 a = 200 ES23-ALU-0200

	Maß a	Art.-Nr.
	ES24 Deckstreifen	a = 50 ES24-RAL-0050
	RAL	a = 100 ES24-RAL-0100
		a = 150 ES24-RAL-0150
		a = 200 ES24-RAL-0200
	ES24 Deckstreifen	a = 50 ES24-VZ-0050
	VZ	a = 100 ES24-VZ-0100
		a = 150 ES24-VZ-0150
		a = 200 ES24-VZ-0200
	ES24 Deckstreifen	a = 50 ES24-VA-0050
	VA	a = 100 ES24-VA-0100
		a = 150 ES24-VA-0150
		a = 200 ES24-VA-0200
	ES24 Deckstreifen	a = 50 ES24-ALU-0050
	ALU	a = 100 ES24-ALU-0100
		a = 150 ES24-ALU-0150
		a = 200 ES24-ALU-0200

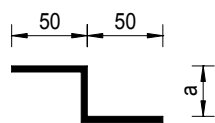

	ES25 Z-Profil	a = 30 ES25-RAL-0030
	RAL	a = 40 ES25-RAL-0040
		a = 50 ES25-RAL-0050
		a = 60 ES25-RAL-0060
		a = 80 ES25-RAL-0080
		a = 100 ES25-RAL-0100
		a = 120 ES25-RAL-0120
		a = 140 ES25-RAL-0140
	ES25 Z-Profil	a = 30 ES25-VZ-0030
	VZ	a = 40 ES25-VZ-0040
		a = 50 ES25-VZ-0050
		a = 60 ES25-VZ-0060
		a = 80 ES25-VZ-0080
		a = 100 ES25-VZ-0100
		a = 120 ES25-VZ-0120
		a = 140 ES25-VZ-0140
	ES25 Z-Profil	a = 30 ES25-VA-0030
	VA	a = 40 ES25-VA-0040
		a = 50 ES25-VA-0050
		a = 60 ES25-VA-0060
		a = 80 ES25-VA-0080
		a = 100 ES25-VA-0100
		a = 120 ES25-VA-0120
		a = 140 ES25-VA-0140
	ES25 Z-Profil	a = 30 ES25-ALU-0030
	ALU	a = 40 ES25-ALU-0040
		a = 50 ES25-ALU-0050
		a = 60 ES25-ALU-0060
		a = 80 ES25-ALU-0080
		a = 100 ES25-ALU-0100
		a = 120 ES25-ALU-0120
		a = 140 ES25-ALU-0140

HINWEIS

Alle Kantteile sind in 4 Standardmaterialvarianten in 3.000 / 4.000 mm erhältlich.

RAL = 25 µ polyesterbeschichtetes, verzinktes Stahlblech Materialdicke: 0,75 mm

VZ = Sendzimirverzinktes Blech / VA = Edelstahl 1.4301 / ALU = Aluminium

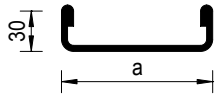

	Maß a	Art.-Nr.
ES26 Boden-U RAL	a = 40	ES26-RAL-0040
	a = 50	ES26-RAL-0050
	a = 60	ES26-RAL-0060
	a = 80	ES26-RAL-0080
	a = 100	ES26-RAL-0100
	a = 120	ES26-RAL-0120
	a = 140	ES26-RAL-0140
	a = 150	ES26-RAL-0150
	a = 160	ES26-RAL-0160
	a = 170	ES26-RAL-0170
	a = 180	ES26-RAL-0180
	a = 200	ES26-RAL-0200
	a = 220	ES26-RAL-0220
	a = 240	ES26-RAL-0240
ES26 Boden-U VZ	a = 40	ES26-VZ-0040
	a = 50	ES26-VZ-0050
	a = 60	ES26-VZ-0060
	a = 80	ES26-VZ-0080
	a = 100	ES26-VZ-0100
	a = 120	ES26-VZ-0120
	a = 140	ES26-VZ-0140
	a = 150	ES26-VZ-0150
	a = 160	ES26-VZ-0160
	a = 170	ES26-VZ-0170
	a = 180	ES26-VZ-0180
	a = 200	ES26-VZ-0200
	a = 220	ES26-VZ-0220
	a = 240	ES26-VZ-0240
ES26 Boden-U VA	a = 40	ES26-VA-0040
	a = 50	ES26-VA-0050
	a = 60	ES26-VA-0060
	a = 80	ES26-VA-0080
	a = 100	ES26-VA-0100
	a = 120	ES26-VA-0120
	a = 140	ES26-VA-0140
	a = 150	ES26-VA-0150
	a = 160	ES26-VA-0160
	a = 170	ES26-VA-0170
	a = 180	ES26-VA-0180
	a = 200	ES26-VA-0200
	a = 220	ES26-VA-0220
	a = 240	ES26-VA-0240
ES26 Boden-U ALU	a = 40	ES26-ALU-0040
	a = 50	ES26-ALU-0050
	a = 60	ES26-ALU-0060
	a = 80	ES26-ALU-0080
	a = 100	ES26-ALU-0100
	a = 120	ES26-ALU-0120
	a = 140	ES26-ALU-0140
	a = 150	ES26-ALU-0150
	a = 160	ES26-ALU-0160
	a = 170	ES26-ALU-0170
	a = 180	ES26-ALU-0180
	a = 200	ES26-ALU-0200
	a = 220	ES26-ALU-0220
	a = 240	ES26-ALU-0240

Darüber hinaus können Sie bei uns
**Zahnbleche, Sickenfüller, Druckverteilerplatten, Befestigungsmaterial, Trapezbleche
 und Paneele sämtlicher Hersteller bestellen. Gerne unterbreiten wir Ihnen ein Angebot.**

ES27 Schnee und Eisfangschiene

RAL

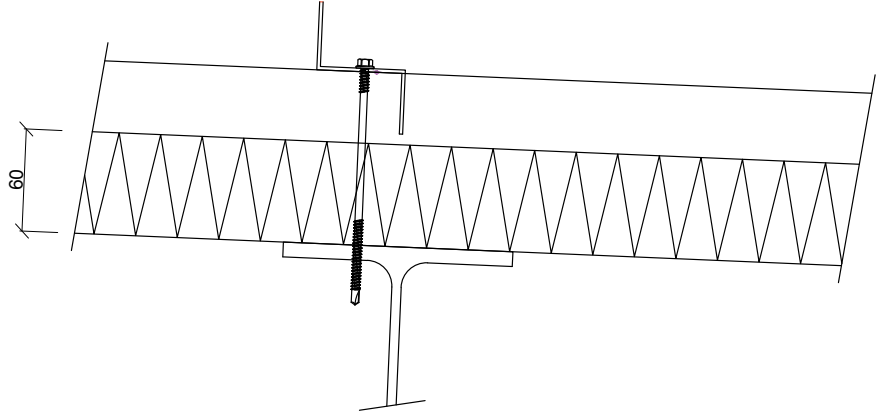

ES28 Zahnblech für Paneel Dach

RAL

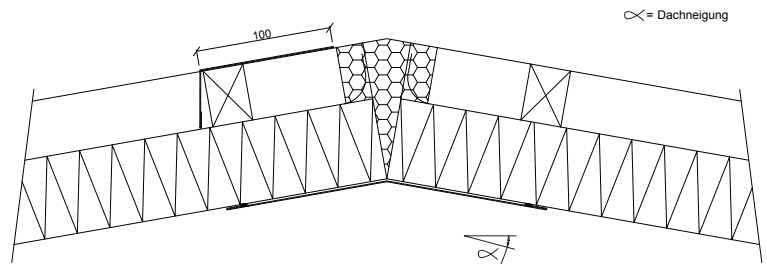

ES29 Zahnblech für Paneel Dach

RAL

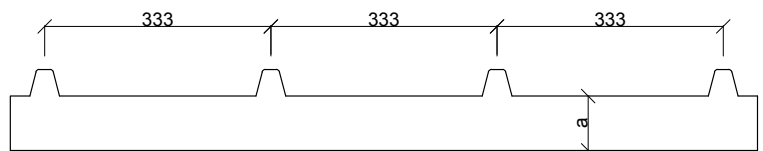
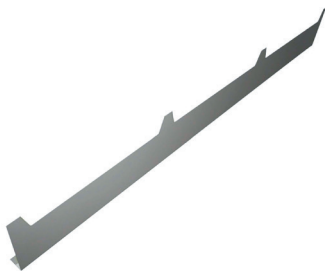

ES30 Druckverteilerplatte 1,5mm

VA

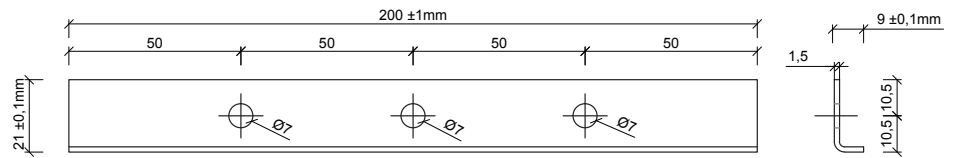

ES31 Druckverteilerplatte 1,5mm

VA

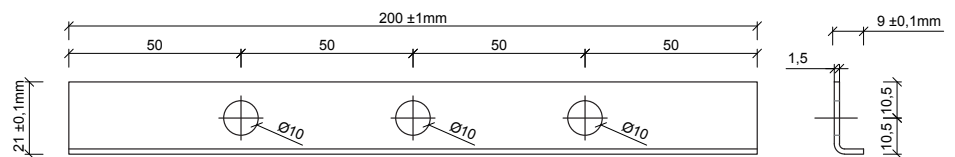

ES32 Druckverteilerplatte 1,5mm

VA

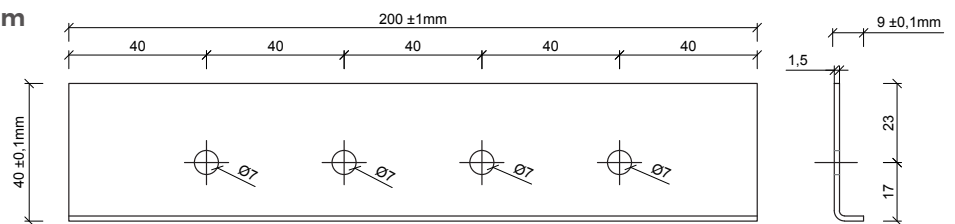

ES33 Druckverteilerplatte 1,5mm

VA

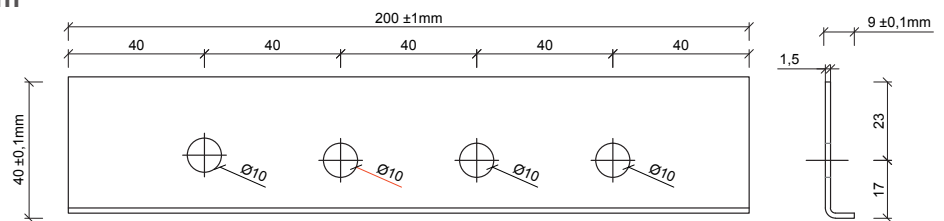

ES34 Druckverteilerplatte 2mm

VA

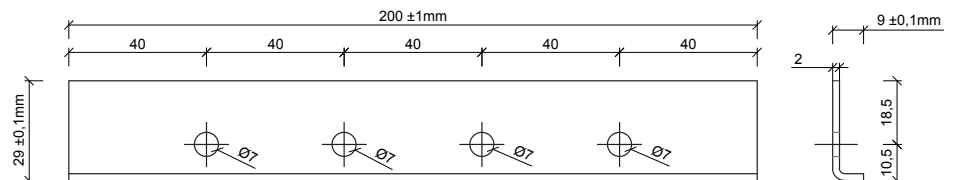

ES35 Druckverteilerplatte 2mm

VA

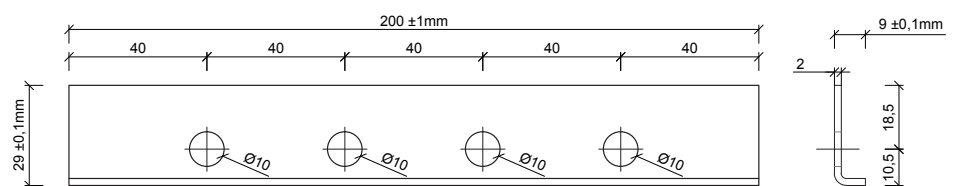

IHR PARTNER FÜR

**PRÄZISION
LIEFERTREUE**



**SONDER
ANFERTIGUNGEN**

SKIZZENBLATT - KANTTEILE

OBJEKT		DATUM	
ORT		WUNSCHTERMIN	
AUFTRAGGEBER		ANSPR.-PARTNER	
AUFTRAGS-NR		BLATT-NR	

POSITION	STÜCK	LÄNGE [MM]	DICKE [MM]	BESCHICHTUNG - A	BESCHICHTUNG - B

ALLE MASSE SIND ALS INNENMASSE (KANTMASSE) ANZUGEBEN. BITTE ALLE ANGABEN AUSREICHEND GROSS & DEUTLICH SCHREIBEN.



STADLER

**NUTZEN SIE
UNSERE KOMPETENZ**

Gewerbepark 1
87775 Salgen
Tel +49 8265 9694 0
Fax +49 8265 9694 50

www.stadler-gmbh.de